

DAQSTATION



DAQSTATION Network Enhanced Model
DX100/DX200

DAQSTATION DX Series Network Enhanced Models display measurement data in real-time on a high resolution TFT color liquid crystal display. Data can be saved to 3.5-inch floppy disks, CompactFlash memory card, or Zip disks. DAQSTATION Network Enhanced Models include a standard Ethernet port with built-in Web Server and E-mail functions and TCP/IP and FTP protocol support. Optional communications include MODBUS with master/slave mode and Foundation Fieldbus. Complete file handling and real-time data logging and configuration functions are supported with PC software. A wide range of display modes let you optimize the view of your process.





DAQSTATION – Data Acquisition Stations for Today's IT World

Standard Networking capability

- Standard Ethernet (10BASE-T) port lets you connect immediately to an existing LAN or WAN.
- Supports network functions such as email notification, on demand monitoring through an Internet browser, and FTP file transfer.
- Supports Yokogawa's "Field Content on the Web™".

A wide variety of display modes

- Every DX is equipped with a high-resolution, wide-angle TFT color liquid crystal display for unparalleled ease of viewing. The DX100 has a 5.5-inch display, and the larger DX200 has a 10.4-inch display.
- A variety of display options are provided, including trend display, bar graph display, numeric display, and overview display.

Storage options for greater flexibility

- Standard- 1.44 MB 3.5-inch floppy disk, Optional- CompactFlash memory card or Zip disk (250 MB) removable PC storage media.
- A variety of files formats and trigger functions allow storage of only the data you need.
- No ink or paper! Digital data increases accuracy and reduces operating cost.

Rugged construction for high reliability

- The internal flash memory does not require battery backup.
- Networking lets you back up large amounts of data to a network PC Server.
- The front panel of the DX Series complies with the IEC529-IP65 and NEMA No.250 TYPE4* standard to keep out dust and grit and water spray.

Seamless network integration through application software

- YOKOGAWA PC software seamlessly integrates DX Series recorders with your network.
- Supports DX configuration, remote monitoring, file transfer, file viewing, and data logging over the network.
- The DAQOPC interface package allows interface to third party client software.

*Except external icing test.

DAQSTATION: Information in the office, intelligence in the field

Companies today face a growing number of challenges—reducing total cost of ownership (TCO), improving efficiency, and controlling quality. As these needs increase, companies must deal with a growing amount of information needed to make informed decisions.

Conventional industrial recorders have been used primarily to monitor and record data in the field. In order to quickly extract information that is valuable to a user from this sea of data, recorders need to be made intelligent. This means they need to have advanced information processing and communication capabilities.

The DAQSTATION DX Series is a family of advanced data acquisition stations designed for today's IT world by Yokogawa, a global leader in recorder technology.



DX100



DX200

DAQSTATION for Rapid Implementation of Field Content on the Web™

Field Content on the Web™

Nowadays, all types of data pass around the world through networks. With the DAQSTATION acting as your gateway, even recorder field data such as temperatures and pressures can be delivered to your office through a communications network.

Field: Field information from a wide area needed by the user
Content: is converted to useful data by measurement technology
on the Web: and delivered over a network. This helps the customer in creating added value.

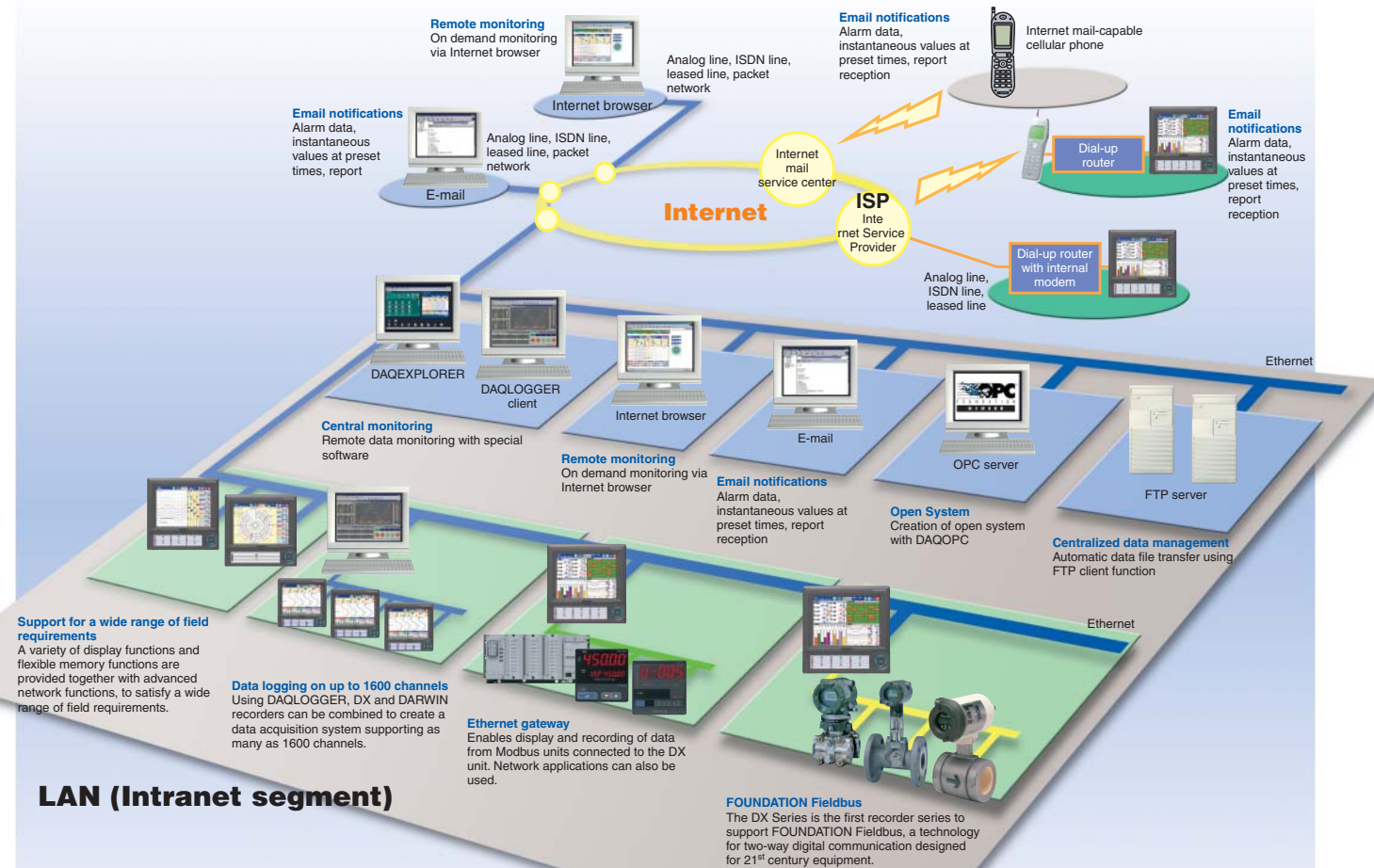

DAQSTATION in a Networked Environment

Standard Ethernet

Every DAQSTATION model is standard-equipped with an Ethernet port (10BASE-T). This facilitates connection to an existing network, and is already in place if you have future plans to create a network. DAQSTATION includes a variety of networking protocols: TCP/IP, the standard protocol for the Internet and LAN/WAN environments; SMTP, a protocol for sending Internet mail; HTTP for remote monitoring with an Internet Web browser; and an FTP client/server function for file transfers. Once your DAQSTATION is installed on your network, you can use the networking functions immediately.

Email notification of DX alarm data and instantaneous values at preset times

The DX Series can send you alarm data, instantaneous values at preset times, report data, power-outage data, and other information via email. Once your DAQSTATION is connected to the Internet, it can send email anywhere. You can even receive DX emails in a remote location using an email-capable cellular phone.

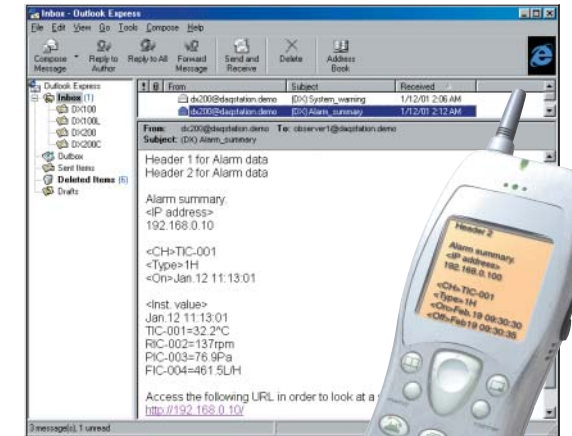

Displaying the DX screen on an Internet browser

You can display the DX screen using an Internet web browser such as Internet Explorer. In addition to displaying the DX screen, your web browser can check alarm status, report instantaneous channel values, and write message data to the DX. The Web server function lets you remotely monitor your DX units, making wide-area on demand monitoring a possibility.

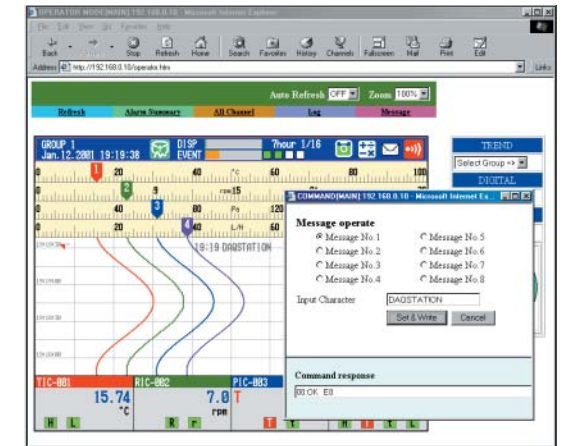

FTP file transfer of DX data

The FTP client function in the DX Series lets you automatically transfer, at preset times, data files saved to the DX unit's internal memory. DAQSTATION supports as many as two servers - a primary server and secondary server. If the primary server fails, files will automatically be transferred to the secondary server.

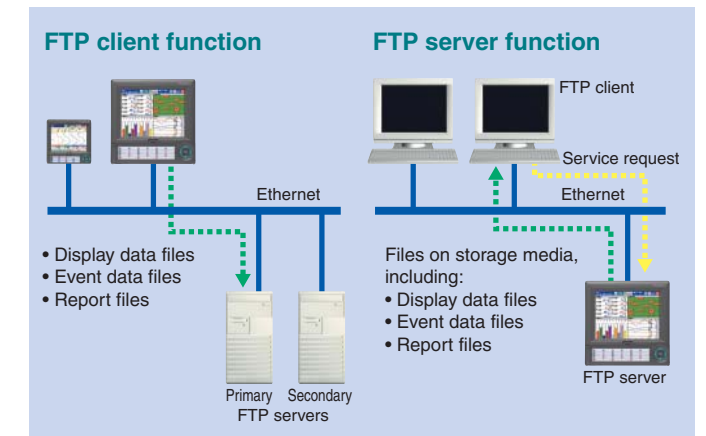

Field Content on the Web

Seamlessly Link the Field and Office with DAQSTATION

Serial Communications

The serial communications option is an RS-232 or RS-422-A/485 (compliant) interface for the DX unit.

Serial Communications

The RS-422-A/485 interface lets you connect up to 32 recorders to a single host computer in a multi-drop configuration.

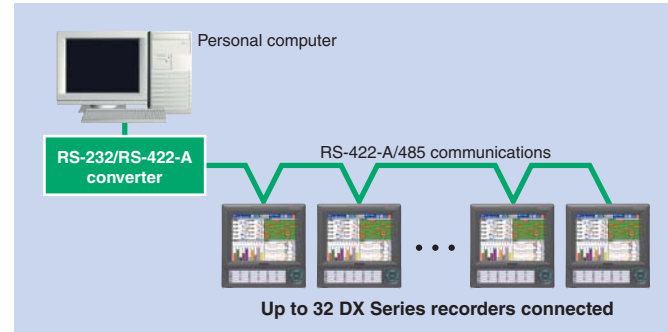

Modbus Communications

DAQSTATION supports the Modbus protocol (RTU master/slave), for easy installation on systems build using Modbus.

Modbus master function

The Modbus master function lets the DX unit read, display, and record digital data from slave devices.

DARWIN connection using Modbus

A Modbus connection lets you input measurements and calculations from a DARWIN Series* data acquisition unit as digital data to DX unit calculation channels. This capability makes it possible to increase the number of DX unit inputs by simultaneously using DARWIN Series measurement/calculation channels.

* Communication module DT300-31/S6 is required. See the general specifications for DT300-31/S6 for further details.

Slave device connection using Modbus

Data from Modbus-compatible devices can be input to DX unit calculation channels as digital data for displaying and recording. For example, the DX unit can produce trend displays and save data such as power monitor cumulative power, indicator regulator setpoints, process values, and outputs.

In addition, data from these devices can be used by DX unit network functions and network applications.

For information on the operating requirements of individual Modbus slave devices, see the specifications for the particular slave device.

Modbus Slave Function

A master device can read DX unit register values. In addition, data written to the register by the host system can be displayed and recorded on the DX unit.

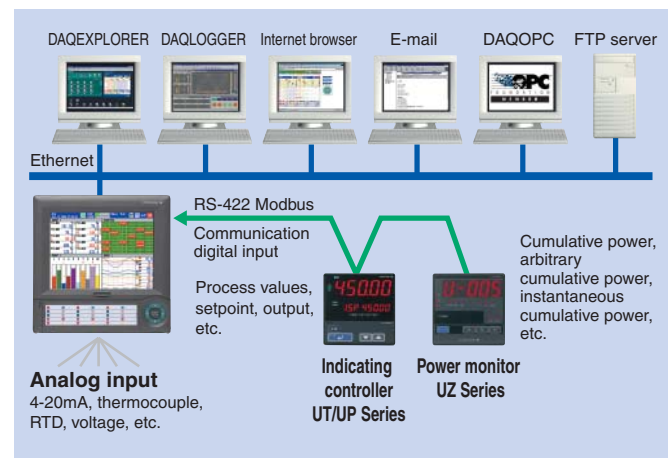
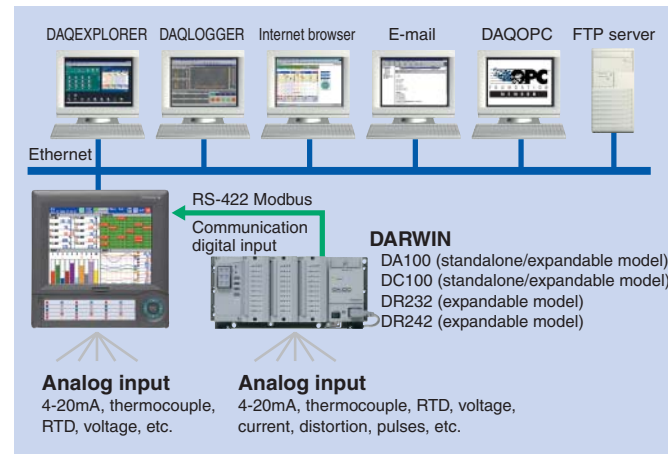

FOUNDATION Fieldbus

DAQSTATION supports FOUNDATION™ Fieldbus, a promising technology for two-way digital communication designed for 21st century equipment.

Advantages of FOUNDATION™ Fieldbus

◆ Fewer wires

Fieldbus enables two-way digital communication with multivariable equipment. This reduces the number of cables, costs, and time-consuming maintenance.

◆ Control at the field level

In addition to communication between a control system and field equipment, Fieldbus enables communication between field units. This means that a number of complex control procedures can reside directly in units dispersed in the field.

◆ Interoperability

With Fieldbus, you can connect a wider variety of equipment to your network than ever before. FOUNDATION™ Fieldbus is a global standard supported by many manufacturers, enabling interoperability between field units and the control system.



FOUNDATION Fieldbus in DAQSTATION

The FOUNDATION Fieldbus option on DAQSTATION enables Fieldbus connections for the DX unit.

Send DX Series measurements to a Fieldbus host system

The DX Series has AI function blocks (eight blocks, one channel each) and an MAI function block (one block with eight channels).

Analog measurements taken by the DX unit are sent as digital data to the Fieldbus and Fieldbus host system. This makes it possible to migrate to Fieldbus using analog output equipment and existing cables.

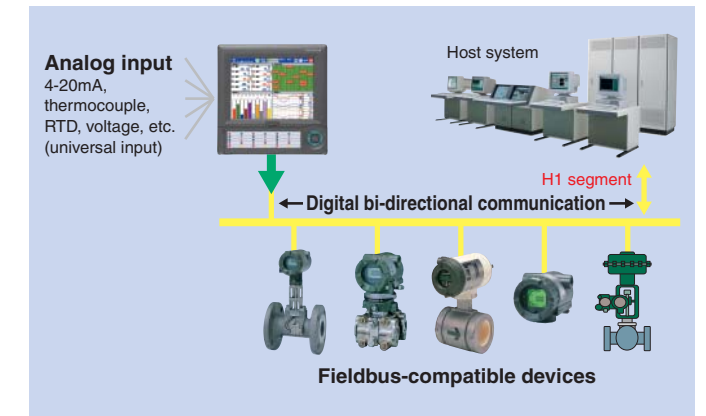

Receive, display and record data from field equipment

The DX Series has an MAO function block (one block with eight channels). Information on the Fieldbus input to the DX unit can be locally displayed and recorded in a variety of formats, including trend display, digital display, and bar graphs. Information on the Fieldbus input to the DX unit MAO can be used together with the DX unit network functions in application software.

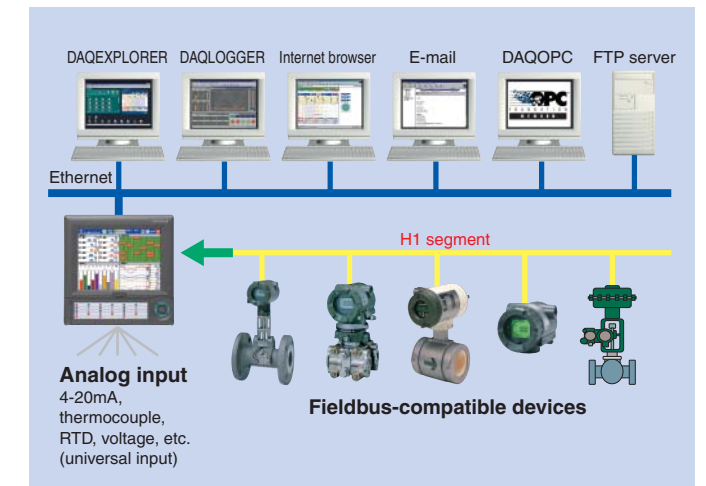

The ideal user interface: Easier to view and easier to use

INTERFACE

Display and controls

DX Series recorders have TFT color liquid crystal displays that provide wide viewing angles. The DX100 has a 5.5-inch QVGA display, and the DX200 has a 10.4-inch VGA display. YOKOGAWA has incorporated a number of refinements that make it easier to display the information you need and give you greater flexibility in displaying information. The controls are designed for easy use and to reduce the likelihood of mistakes. The panel keys, which are used for entering various settings, are separated from the control keys used to perform ordinary user actions. The cover over the panel keys is detachable. Even when this cover is removed, the case still satisfies the standard for keeping out particles and moisture (IP65/NEMA No.250 TYPE4 compliant).

■ Display and controls



1 Trend display area

This area displays Trend Lines, together with scale values and engineering units for each channel along with user selectable messages. Trend Display orientation (vertical or horizontal) and background color (white or black) are also user selectable. Pen scale display is also available.

2 Digital display area

This area displays digital measurement values, together with channel or tag numbers, industrial units, and alarm statuses for each channel.

3 DX status display area

This area graphically presents the DX operating status.

4 Display mode menu

Pressing the Navigation key, shows the display mode menu. You can then select a menu option with the operation keys to switch between displays.

5 Navigation keys

The Navigation keys are used for functions such as switching display modes, primarily during normal operations (in operation mode). When entering settings, the Navigation keys are used to move the cursor.

6 Key panel

The key panel contains function keys, memory sampling START/STOP keys, and a numerical keypad (DX200 only). These keys are primarily used to perform various actions related to data recording, and to enter settings in the DX recorder.

7 Removable storage media drive

The DX Series may have different types of removable storage media (3.5-inch floppy disk, CompactFlash memory card, or Zip disk). The media type can be selected when ordering a DX Series. During normal operations, the drive is well protected by a cover to ensure media and drive reliability.

■ Other display modes

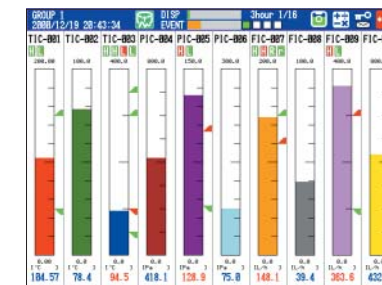

Bar graph display

Vertical or Horizontal bar graphs can be selected in the bar graph display mode.



Split screen display

This mode lets you split the screen into four areas, and select the display format for each of the areas.

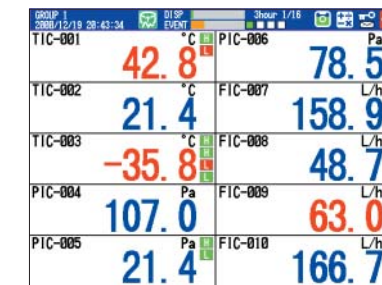

Large-font numeric display

Large-font digital display
The digital display mode shows measured data as numeric values, and displays channel number, tag name, engineering units, and alarm status.



Overview screen

This screen lets you monitor the alarm statuses and numeric value for all channels.

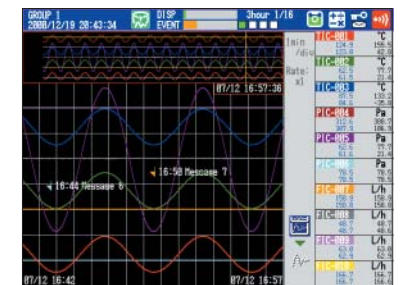

Historical trend display

This display mode allows you to display historical data stored in memory. From the overview display, select the area you want to view and jump to a historical trend of the data.

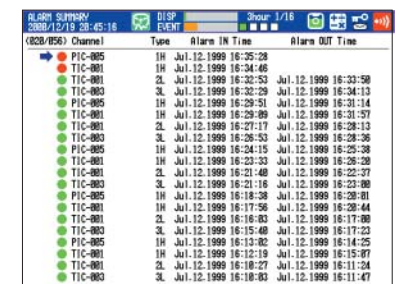

Information screen

This information screen displays alarm summary, message summary, memory information or media information.

DAQSTATION provides the recorder display features you need.

■ Quickly find old records

• With conventional recorders, the process of removing the paper to locate specific data is very inefficient.

In contrast, the DX series lets you quickly find and display the data you need including alarm and message summaries. You can also select and enlarge a desired part of a trend overview screen using the cursor.

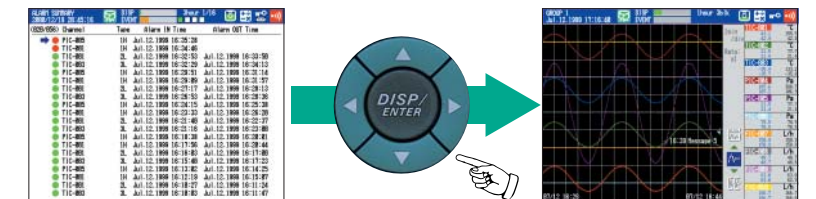

■ Optimizing the display format for the measurement type

• Users often want to use different display formats for different types of data. Sometimes a trend display is best, while in other cases it is necessary to monitor levels.

The DX Series provides a wide range of display formats, including trend display, bar graph display, and large numeric value display. These features let you monitor data using the best display format for the application. The DX200 also has a split-screen feature that lets you display four different areas in different display modes.

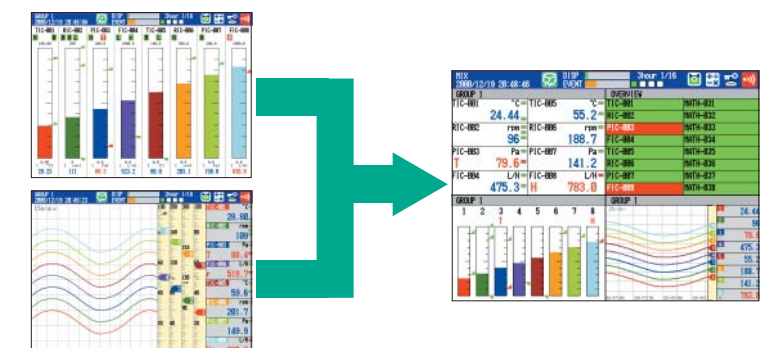

The recording system used with the DX Series has a variety of recording options and is very flexible. It can significantly improve your efficiency in taking field measurements.

Memory Function

DAQSTATION provides a variety of recording options that go far beyond the capabilities of conventional recorders. These features let you efficiently record just the data you need, saved to your choice of removable PC storage media.

Optional PCMCIA ATA flash memory card or Zip disks allow data recording over extended periods of time in automated recording systems.

DAQSTATION Recording System measured data

Recording mode

The DX Series saves measured data to internal protected memory, and then copies the saved data file(s) to the removable storage media in AUTO or MANUAL mode. The internal memory consists of nonvolatile flash memory that does not require a battery backup. This means you won't lose your data in the event of a power failure.

(MANUAL mode)

In MANUAL mode, the data held in internal memory are stored on removable storage media when you insert the media in the drive. This mode is useful in cases where you want to store a relatively small amount of data on a floppy disk for quick checking.

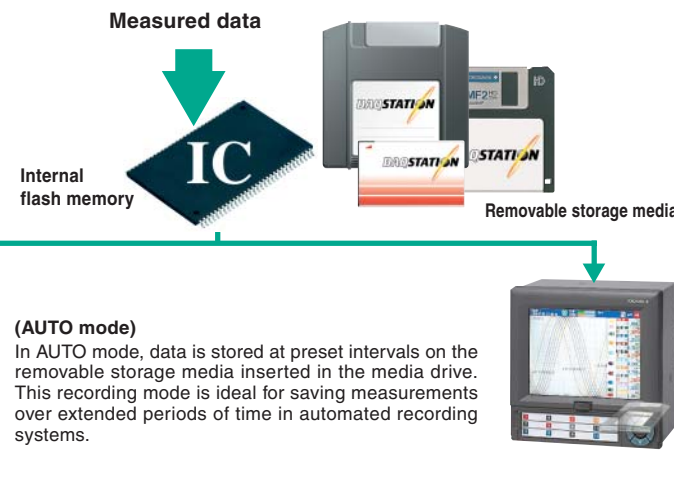

(AUTO mode)

In AUTO mode, data is stored at preset intervals on the removable storage media inserted in the media drive. This recording mode is ideal for saving measurements over extended periods of time in automated recording systems.

Data files

Data files

The DX Series lets you store measurement data either as Display data files or Event files. These two file types serve different purposes, which provide greater flexibility in recording your data.

Display data files — for recording long-term trends

Display data files contain waveform display data. Each time the waveform screen display is updated, the minimum and maximum channel values calculated since the last update are written to the display file (Fig.1)

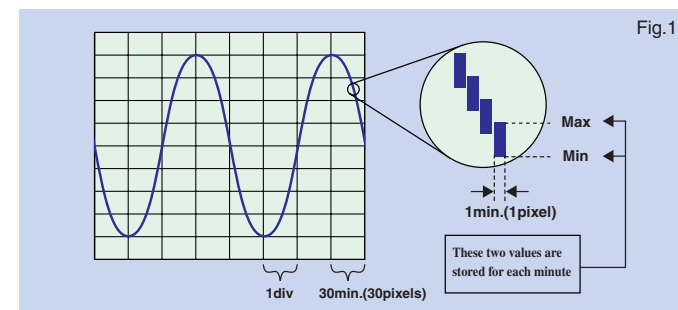

Trigger functions

Event files, combined with trigger functions, provide a powerful tool for detecting and analyzing abnormal data. Pretrigger settings can also be made, so data preceding and following a trigger can be analyzed. (Fig.2)

The following shows the waveform display updating period (time per time-axis div), the data saving interval and the data saving period.

DX106 without calculation channel

Display updating (min/div)	1 minute	5 minute	20 minute	30 minute	60 minute	240 minute
Saving interval (seconds)	2 seconds	10 seconds	40 seconds	60 seconds	120 seconds	480 seconds
Sampling time	Approx. 27 hours	Approx. 5 days	Approx. 23 days	Approx. 34 days	Approx. 69 days	Approx. 277 days

Event files — for detailed data analysis

Event files contain the instantaneous channel values saved at a specified storage interval.

These two file types can be used either independently or in combination:

- 1 Display data file only
- 2 Event data file only
- 3 Display data file combined with event data file

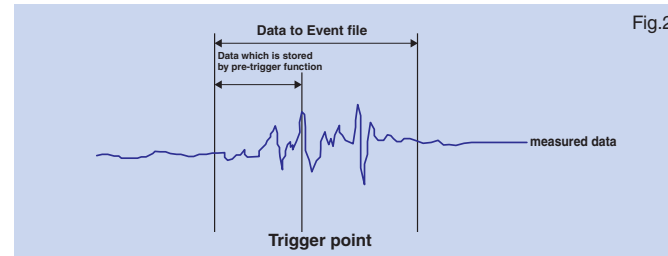

Application Examples

Now that you know something about the DAQSTATION, you're probably wondering how it can be used in your applications. A number of sample applications are presented below to give you some ideas.

Continuous recording

with an emphasis on "continuous"

The ability to record continuously is important when:

- You have a factory that's running 24 hours a day and want to be able to monitor and record data constantly.
- You want to keep records of the water level of a dam in a remote location, but you can't get out to the location on a regular basis.

What do you do? Well, in such cases, you can save your measurements in AUTO mode using large capacity storage media such as CompactFlash memory card or Zip disks. Insert the media in the drive on the DX Series. Now simply press the start button and you're ready for extended, continuous measurement recording. There's no need to worry about running out of ink or changing recording paper as in the case of conventional paper recorders.

The DX106 (6-channel model, no calculations, display updating interval of 30 minutes per div (data saved every 60 seconds)), together with a 32 MB CompactFlash memory card, will actually let you record data in a display data file continuously for a year or longer.

Recording just the data you need

The ability to record just the data you need is important when:

- You only need the data recorded between the time you arrive at a site in the morning and when you leave in the evening.
- You want to collect experimental data through a simple procedure (just starting and stopping the recording process).

The DX Series recording Start and Stop buttons let you record just the data you need. For data recorded over extended periods of time, an ATA flash memory card or Zip disk can be used to save data in AUTO mode. Each time the recording process is stopped, a new file is saved on the storage media. If you don't require recording over extended periods of time, you can save data to a floppy disk in MANUAL mode for easy analysis.

Capturing abnormal data

The ability to capture abnormal data is important when:

- You want to detect and record data under abnormal conditions for detailed analysis on a PC.

The DX Series' trigger functions and event file capabilities are useful for this purpose. The trigger functions are easy to use once you specify a trigger source and data length (sample time). For example, by setting alarms as the trigger source and setting the data length (sample time) to ten minutes, you can create a 10-minute event file each time an alarm occurs. The DX Series also has pre-trigger functions that let your record and analyze data preceding a trigger.

Recording extended-period data and detailed data at the same time

The ability to record extended-period data and detailed data at the same time is important when:

- You want to continuously record the temperature of turbine bearings 24 hours a day, while simultaneously making a detailed analysis twice a day of just the measurements obtained at turbine startup and shut-down.

The combination of display data files and event files eliminates the need for two separate recorders. Do your continuous recording on display data files, and record the measurements obtained at turbine startup and shutdown in event files based on triggers. (Fig.3)

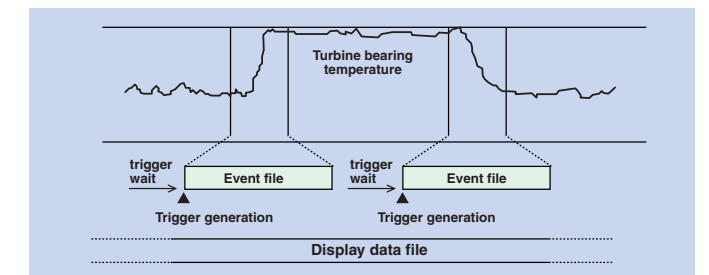

Batch file recording for measurements related to food and drugs applications

The ability to use batch file recording is important when:

- You want to record a batch process, including batch numbers and comments with each batch file.

The optional batch function lets you add batch numbers (text strings as long as 16 characters, followed by four-digit serial numbers) and comments (text strings as long as three lines of 32 characters each) to each batch file. This information can be viewed when you open the data files on a PC.

Creating reports automatically

The ability to create reports automatically is important when:

- You need daily and monthly reports based on recorder data, but don't want to go through the hassle of reading the data from the recording paper and preparing the reports manually.

The optional calculation function enables DX Series to produce reports automatically based on the measured data. The DX Series can create reports in hourly, daily, weekly, daily+weekly and daily+monthly formats. Average values, maximum values, and minimum values for fixed time intervals, as well as cumulative values are calculated and recorded in reports. Report data created and saved with a DX Series can be opened and worked with on a PC. This greatly improves reporting efficiency.

High reliability based on years of expertise

HIGH RELIABILITY

The important thing is the data

It is not an exaggeration to state that the DAQSTATION's reliability is equivalent to data reliability. After all, it's the data you're concerned about. YOKOGAWA's goal is to provide you with the highest level of reliability, so that you never lose any measurements.

Protecting data during a power interruption

The DX Series uses flash memory as internal memory for storing measurement data. Flash memory is a type of nonvolatile memory that does not require a battery backup. Power interruptions will not cause it to lose stored data.



Keeping data secure

The DX Series saves measurement data (display data and event data) in binary format. The binary data provides a high level of security. If binary data is overwritten, a notification message will appear on your PC when you open the file as an alert. Another feature to protect your DX Series from unauthorized access is the login function. This function only allows authorized users access to your DX Series recorders.

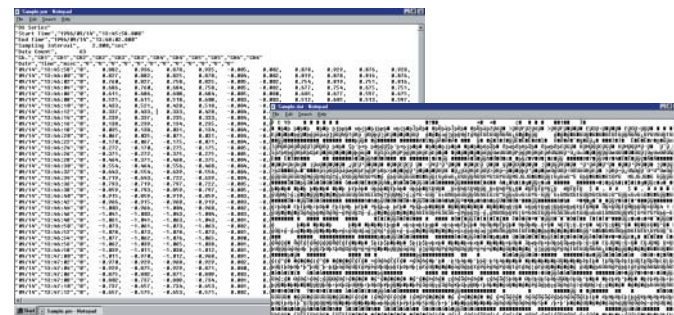

ASCII data

Binary data

Backing up data

DX Series measurement data is initially saved to the internal flash memory, then transferred to the removable storage media either periodically (in AUTO mode) or when you insert the media in its drive (in MANUAL mode). For this reason, even if your removable storage media is damaged, the most recent

measurement data will remain protected in your DX's internal memory. You can make your data backups even more secure by periodically transferring data files to a file server using the FTP client function.

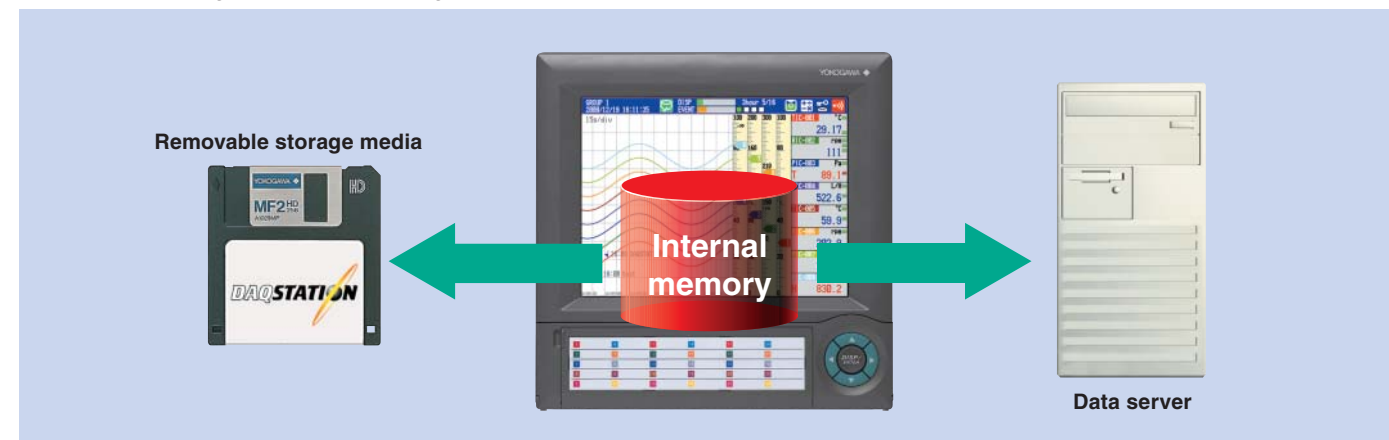

Reliable hardware

In the half-century since introducing the ER electron-tube automatic balancing recorder (Japan's first) in 1951, YOKOGAWA has shipped more than one million industrial recorders to users around the world. The DX Series DAQSTATION incorporate the highly reliable technology that YOKOGAWA has developed through its many years of expertise as a recorder manufacturer.

Dust-proof and water-proof front panel (IP65, NEMA No.250 TYPE4* compliant)

YOKOGAWA designed the DX Series to be used under harsh environmental conditions. The front panel has a dust-proof, water-proof design which is compliant with the IEC529-IP65 and NEMA No. 250 TYPE4* standard. This structure provides good protection for the recorder's internal components as well as the removable storage media drive mechanism. Compliance with IP65 means that the front panel has met stringent requirements such as complete protection (of internal components) against dust, and protection against functional errors even when the recorder is sprayed with a jet stream. The DX Series' ability to endure such environmental conditions has been proven through stringent evaluation tests.

*Except external icing test.



Quality components

• High-breakdown-voltage solid-state relays

DX Series use high-breakdown-voltage solid-state relays developed by YOKOGAWA as scanners for switching input signals. These relays consist of MOSFETs capable of withstanding high voltage (1500 V DC) with low leakage current (3 nA), and power-output photocouplers. They provide high-speed scanning (30 channels per second in the DX230) while increasing scanner life and eliminating noise.

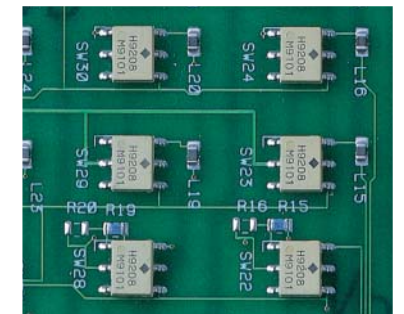

• Isolated channel inputs

DC voltage and thermocouple inputs in all DX Series models are channel-isolated. (Channel isolation for RTD inputs is optional on some models.) The high common mode noise characteristic enabled by isolated channel inputs ensures stable measurements in a wide range of fields.

• M4 screw input terminals

Input terminals are the "entryways" through which all measurements enter a recorder. Their reliability is critical to enabling stable data collection. Rugged M4 screw input terminals are used in all DX Series recorders.



• Compliance with safety standards and EMC standards

Another indication of the reliability of DX Series is their compliance with the stringent specifications for international safety and electromagnetic compatibility (EMC) standards. Of course, DX Series have also been approved for the CE standards.

- CSA: CSA22.2 No1010.1 installation category II, pollution degree 2
- UL: UL61010B-1 (CSA NRTL/C)
- CE: EMC directive: EN61326 compliance (Emission: Class A, Immunity: Annex A)
 - EN61000-3-2 compliant
 - EN61000-3-3 compliant
 - EN55011 compliant, Class A Group 1
- Low voltage directive: EN61010-1 compliant, measurement category II, pollution degree 2
- C-Tick: AS/NZS 2064 compliant, Class A Group 1



Application software to further expand the potential of DAQSTATION



Application software

The application software options, which let you open and work with data recorded on DX Series and easily use DX network functions, are an integral part of DAQSTATION recorders. They will help you integrate your DX Series with your PCs and network.

DAQSTANDARD (compatible with Windows 98/Me/NT 4.0/2000/XP)

DAQSTANDARD is a standard software package included with the DX Series. It can be used to print or redisplay data files saved by the DX unit or transferred through FTP.

• Setup module

The Setup module is used to send the DX unit data such as settings relating to measurement channels, calculation channels, or the screen display. It can also receive settings from the DX unit and save them to a PC hard disk or other storage device.

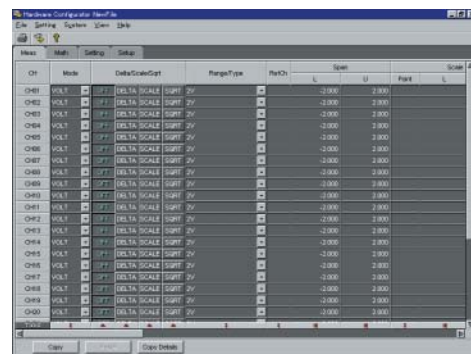

Measurement channel settings

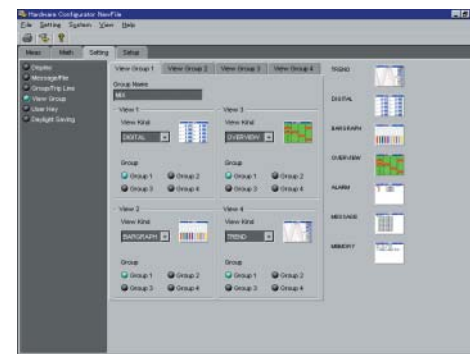

Display settings

• Data Viewer

The Data Viewer module can be used to display and print data in files generated by the DX unit. Data can be displayed as trend displays, digital displays, circular displays, and lists. In addition, the cursor can be used to read numerical values in displayed data, or to make interval calculations. Data can be converted to ASCII, or to file formats that can be opened in Excel or Lotus 1-2-3.

• Linked file display

Data files generated by breaking up contiguous data into multiple files as a result of auto-saving or a power interruption during continuous data acquisition by the DX unit can be displayed as linked files. You can save the file linking conditions, so it is easy to redisplay linked files. Using the linked file display, you can also convert data to ASCII or file formats that can be opened with Excel and Lotus 1-2-3.

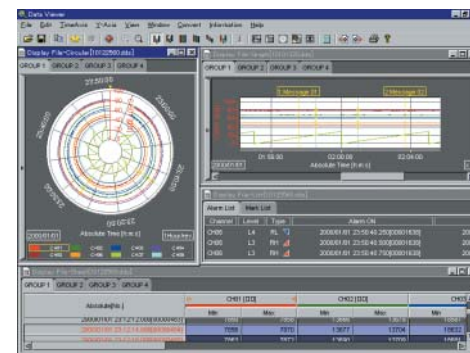

Data Viewer

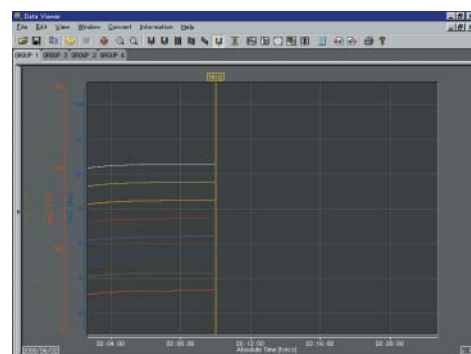

<Before linking>

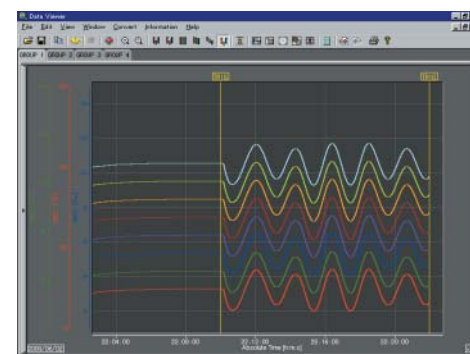

<After linking>

DAQEXPLORER (compatible with Windows 2000/XP)

DAQEXPLORER is a software package that supplements the DAQSTANDARD features with functions such as Desktop and Data Monitor. DAQEXPLORER lets you take full advantage of network functions through the DX unit's Ethernet connection.

■ GUI-based user-friendly operations

DAQEXPLORER makes it easy to perform tasks such as entering DX settings over a network or transferring measurement data files from a DX series unit to a PC. Simply click or drag and drop icons on the Desktop.

■ A variety of user-friendly software modules in a single package

The DAQEXPLORER package contains various software modules, such as:

- Data Monitor module for monitoring DX measurements over the network
 - Data Viewer module for playing back and displaying data files generated by the DX unit
 - Setup module for entering various settings
- Individual modules can be accessed by simply clicking the module icons on the Desktop. In addition, an optional auto-file-conversion function improves the efficiency of data processing tasks through automatic conversion of data files.

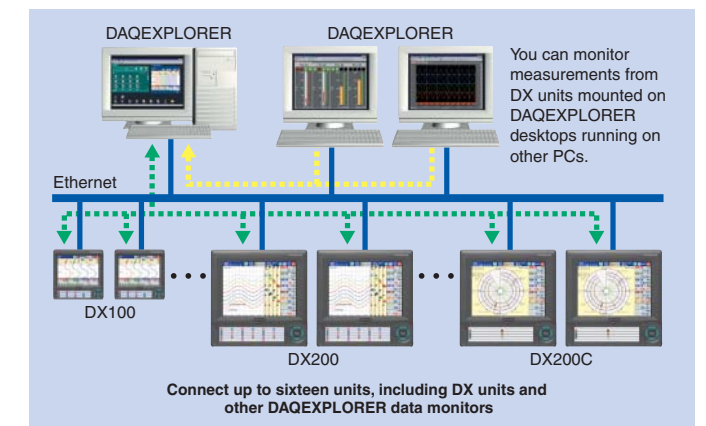

• Desktop

The Desktop is a space which integrates the DAQEXPLORER software modules and allows you to manage the DX units on the network. All basic actions are performed by simply clicking or dragging and dropping icons. The Desktop also automatically searches for and displays DX units that are connected to the network (within the same segment as the PC you are using). Normally this eliminates the need to perform bothersome setup tasks such as specifying IP addresses or host names.

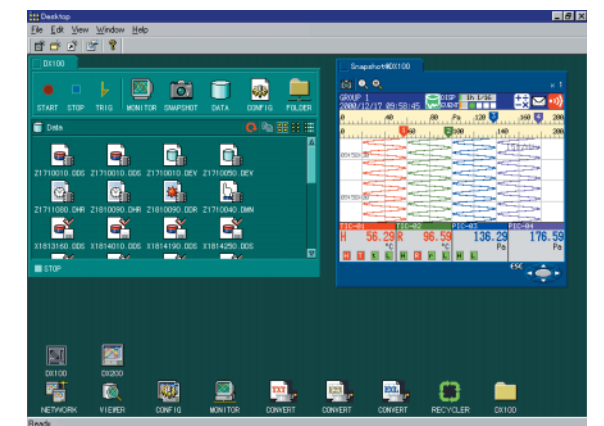

Desktop

• Data Monitor module

The Data Monitor module allows you to monitor measurement data from DX units on the network in a variety of formats. Available formats include trend display, circular trend display, digital value display, and meter display. This module also lets you monitor measurements from DX units mounted on DAQEXPLORER desktops running on other PCs.

• Auto-file-conversion function (optional)

With the DAQEXPLORER automatic file transfer function and auto-file conversion function, data files are transferred automatically from a DX unit to DAQEXPLORER and are automatically converted to the specified format at the same time. In addition, it is possible to batch-convert multiple data files saved in a DAQEXPLORER data folder.

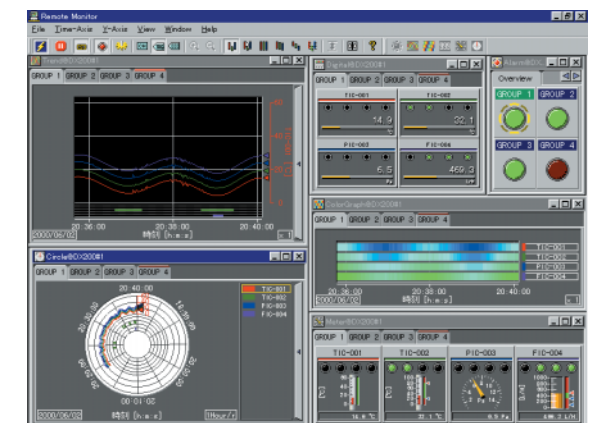

Data Monitor

DAQLOGGER (compatible with Windows 2000/XP)

DAQLOGGER is a data-logging program that works simultaneously with Ethernet and serial interfaces. It allows you to interface with μ R Series industrial recorders, VR Series view recorders, DARWIN Series, and DAQSTATION, connecting as many as 32 of these devices on up to 1600 channels simultaneously.

■ A variety of user-friendly software modules in a single package

Individual modules such as Viewer can be accessed by simply clicking the module icons using the special Manager module. DAQLOGGER includes a variety of features, such as Event Processor, DDE server function, file utilities, and report function.

■ Client and server functions

As many as 16 client PCs on Ethernet links can remotely access DAQLOGGER during data collection via a server PC for remote data monitoring.

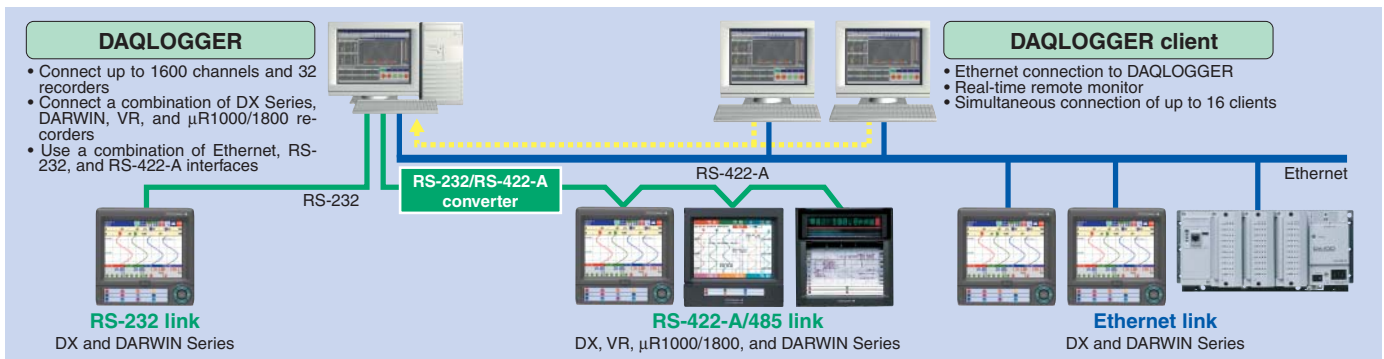

• Manager module

The Manager module is used for starting modules such as the Setup module and file utilities. It is also used to enter Event Processor settings, and to start, run, and stop data acquisition.

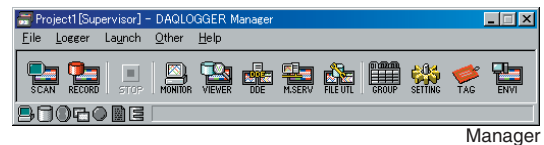

• Data Monitor module

The Data Monitor module allows you to monitor measurement data and calculations in a variety of formats. Available formats include trend display, digital value display, and meter display.

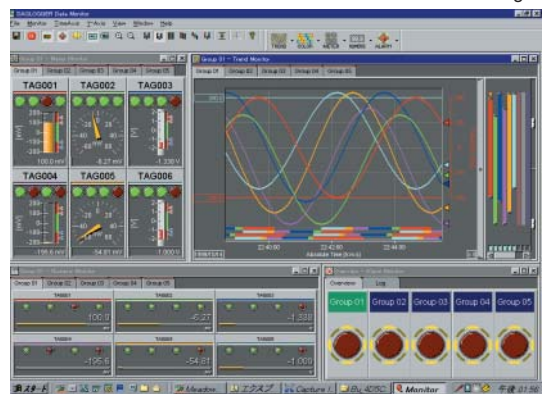

• Event Processor

The Event Processor automatically performs actions such as sending email, FTP file transfer, PNG file output, and file conversion when a specified event occurs (e.g., alarm, file creation, or preset time).

DAQOPC (compatible with Windows 2000/XP)

DAQOPC supports the optional browse function and OPC standard interface function (Data Access server function) specified by the OPC Foundation.

• Data Access server function

When DAQOPC is used by an OPC client, this function enables writing of communication input data and reading of DX Series process data using an item ID as an identifier.

• Browse function

This function allows an OPC client to browse DAQOPC contents (item IDs).

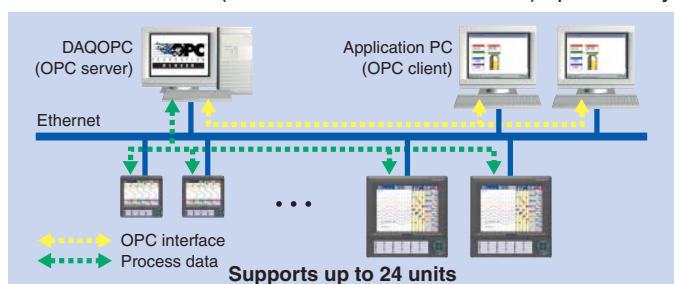

Example configuration

Specifications

See the general specifications (GS 04L01A01-00E and GS 04L02A01-00E) for the detailed specifications.

SPECIFICATIONS

Standard Specifications

General Specifications

Attachment:	Embedded panel (vertical panel) The attachment angle may be slanted 30° to the rear. Left-right horizontal.
Attached panel thickness:	2-26 mm
Materials:	Case: Steel Bezel: Polycarbonate Front filter: Polycarbonate
Paint colors:	Bezel: Charcoal gray light (Munsell 10.0B 3.6/0.3 or equivalent) Case: Grayish blue-green (Munsell 2.0B 5.0/1.7 or equivalent)
Front panel dustproof/water resistance specifications:	Compliant with IEC529-IP65 Compliant with NEMA No. 250 TYPE4 (except icing test)

Input unit

Number of inputs and measurement periods

Model	Inputs	Measurement period	Event file sampling period
DX102	2	125 ms	125,250,500 ms
DX104	4		1,2,5,10,30,60,120,300,600 s
DX106	6	1 second (2 seconds for A/D integration time of 100 ms)	1,2,5,10,30,60,120,300,600 s
DX112	12		
DX204	4	125 ms	125,250,500 ms
DX208	8		1,2,5,10,30,60,120,300,600 s
DX210	10	1 second (2 seconds for A/D integration time of 100 ms)	1,2,5,10,30,60,120,300,600 s
DX220	20		
DX230	30		

Measurement range :

Input type	Range	Measuring range
DCV	20 mV	-20.00 to 20.00 mV
	60 mV	-60.00 to 60.00 mV
	200 mV	-200.0 to 200.0 mV
	2 V	-2.000 to 2.000 V
	6 V	-6.000 to 6.000 V
	20 V	-20.00 to 20.00 V
	50 V	-50.00 to 50.00 V
TC	R *1	0.0 to 1760°C / 32 to 3200°F
	S *1	0.0 to 1760°C / 32 to 3200°F
	B *1	0.0 to 1820°C / 32 to 3200°F
	K *1	-200.0 to 1370°C / -328 to 2498°F
	E *1	-200.0 to 800°C / -328.0 to 1472.0°F
	J *1	-200.0 to 1100°C / -328.0 to 2012.0°F
	T *1	-200.0 to 400°C / -328.0 to 752.0°F
	N *1	0.0 to 1300°C / 32 to 2372°F
	W *2	0.0 to 2315°C / -328.0 to 4199°F
	L *3	-200.0 to 900°C / -328.0 to 1652.0°F
	U *3	-200.0 to 400°C / -328.0 to 752.0°F
RTD *5	Pt100 *4	-200.0 to 600°C / -328.0 to 1112.0°F
	JPt100 *4	-200.0 to 550°C / -328.0 to 1022.0°F
DI	DCV input (TTL)	OFF: less than 2.4 V ON: more than 2.4 V
	Contact input	Contact on/off

*1 R, S, B, K, E, J, T, N: IEC584-1 (1995), DIN IEC584, JIS C 1602-1995
 *2 W: W-5%, Rd/W-26% Rd (Hoskins Mfg. Co.), ASTM E988
 *3 L: Fe-CuNi, DIN43710, U: Cu-CuNi, DIN43710
 *4 Pt100: JIS C 1604-1997, IEC 751-1995, DIN IEC751-1996, JPt100: JIS C 1604-1989, JIS C 1606-1989
 *5 Measuring current: i = 1 mA

Thermocouple burnout : Detector ON/OFF switching
Burnout upscale/downscale switching

Calculations :

- Differential calculation : The difference between any two channels can be calculated.
Calculable inputs : DCV, TC, RTD
- Linear scaling :
Scalable inputs : DCV, TC, RTD
Scalable range : -30,000 to 30,000
- Square root :
Scalable input : DCV
Scalable range : -30,000 to 30,000

Display

Display:	DX100: 5.5-inch color TFT LCD (320 × 240 pixels) DX200: 10.4-inch color TFT LCD (640 × 480 pixels) * Some LCD display pixels may remain constantly on or constantly off, and brightness variations may occur due to the properties of the liquid crystal. Please note that this does not mean the display is broken.
Trend/bar graph display colors:	DX100: Any of 12 colors DX200: Any of 16 colors White or black
Background:	White or black
Status display:	Display group name, login user name (when using login function), time (year/month/date, hour:minute:second), batch name (with /BT1), recording operation, memory status, media status, calculation status, key lock status, email status, main alarm display
Display types:	Measurement data display (trend display, digital display, bar graph display), overview display, information display (alarm summary, message summary, memory summary), historical display
Trend display:	Number of screens: 4 (4 groups) Number of display channels: DX100: Up to 6 channels per screen or all channels DX200: Up to 10 channels per screen or all channels Waveform update rates: DX102, DX104: 15/30 seconds; 1/2/5/10/20/30 minutes; 1/2/4/10 hours/div DX106, DX112: 1/2/5/10/20/30 minutes; 1/2/4/10 hours/div DX204, DX208: 15/30 seconds; 1/2/5/10/20/30 minutes; 1/2/4/10 hours/div DX210, DX220, DX230: 1/2/5/10/20/30 minutes; 1/2/4/10 hours/div

Direction: Vertical or horizontal
Thickness: 1, 2, or 3 dots
Scale: DX100: 6
DX200: 10

Message display:	Display of messages input through key input, communication, or remote input
Digital display information:	Digital value display, tripline, grid, hour:minute, update rate
Digital display:	Number of screens: 4 (4 groups) Number of display channels: DX100: Up to 6 channels per screen or all channels DX200: Up to 10 channels per screen or all channels Update rate: 1 second Display contents: Measurements, channel/tag names, units, alarm statuses
Bar graph display:	Number of screens: 4 (4 groups) Number of display channels: DX100: Up to 6 channels per screen or all channels DX200: Up to 10 channels per screen or all channels Update rate: 1 second Direction: Vertical or horizontal Scale: 4 to 12 Reference position: Edge or center (only during horizontal display) Display contents: Measurements, channel/tag names, scale upper/lower limits, units, alarm statuses, upper/lower limit alarm points
Overview display:	Update rate: 1 second Display contents: Measurements and alarm statuses on all channels
Information display:	Display types: Alarm summary, message summary, memory information, etc.
Split screen display (DX200):	Display contents: The screen is divided into four windows. Any display type/display group may be displayed in the windows from measurement data display or information display. Number of stored display types: 4 maximum
Data reference functions:	Function: Redisplay of data from internal memory or removable storage media Display data: Display data files, event data files Display layout: Split screen (two parts) or full screen Time-axis actions: Reducing, enlarging, scrolling

Storage functions

Removable storage media: The following removable storage media options are available when ordering a system:

- 3.5-inch floppy drive (2HD)
- Zip drive (250MB)
- CompactFlash memory card (CF+Adapter)

File types: The following data are saved on removable storage media:

File type	Data contents	Format
Display data	Maximum and minimum values in the waveform update period, from data sampled in the measurement period	Binary
Event data	Instantaneous values sampled in specified sampling period	Binary
Manual sample data	Instantaneous values for each key input or contact input	ASCII
Statistical calculation (TLOG) data*	Data at TLOG time-out	Binary
Report data*	Data at report time-out	ASCII
Settings file	Settings for set mode/setup mode	ASCII

* When using calculation option (M1)

Data saving period: Display data: Linked to waveform update rate.
Event data: Specify the sampling period.

Event data file trigger: Free, trigger, or rotate
Measurement data file combinations:
The following combinations of display data files and event files are permitted:

- Display data file only
- Event file (trigger, rotate, free) only
- Display data file + event file (trigger, rotate)

Data size: Display data: Measurement data: 4 bytes/record
Calculation data: 8 bytes/record
Event data: Event data : Measurement data: 2bytes/record
Calculation data: 4 bytes/record

Display data files only

Display updating (min/div)	1 minute	5 minutes	20 minutes	30 minutes	60 minutes	240 minutes
Saving interval (seconds)	2 seconds	10 seconds	40 seconds	60 seconds	120 seconds	480 seconds
Sampling time	Approx. 27 hours	Approx. 5 days	Approx. 23 days	Approx. 34 days	Approx. 69 days	Approx. 277 days

Event data files only

Saving interval	1 second	5 seconds	10 seconds	30 seconds	60 seconds	120 seconds
Sampling time	Approx. 27 hours	Approx. 5 days	Approx. 11 days	Approx. 34 days	Approx. 69 days	Approx. 138 days

Displays data files + event files / Display data files

Display updating (min/div)	1 minute	5 minutes	20 minutes	30 minutes	60 minutes	240 minutes
Saving interval (seconds)	2 seconds	10 seconds	40 seconds	60 seconds	120 seconds	480 seconds
Sampling time	Approx. 20 hours	Approx. 4 days	Approx. 17 days	Approx. 26 days	Approx. 52 days	Approx. 208 days

Display data files + event files/Event files

Saving interval	1 seconds	5 seconds	10 seconds	30 seconds	60 seconds	120 seconds
Sampling time	Approx. 6.9 hours	Approx. 34 hours	Approx. 2 days	Approx. 8 days	Approx. 17 days	Approx. 34 days

Specifications

See the general specifications (GS 04L01A01-00E and GS 04L02A01-00E) for the detailed specifications.

File saving method: Auto save or manual
 Auto save: Display data file: Saved to removable storage media at fixed intervals (10 minutes to 31 days).
 Event file: Saved to removable storage media at fixed intervals (3 minutes to 31 days) with free trigger, or saved at end of sampling with trigger or repeat.
 Manual save: Data saved when removable storage media is inserted.

Alarm functions

Number of settings: Maximum 4 per channel
 Alarm types: Upper/lower limits, difference upper/lower limits, change rate increase/decrease limits, delay upper/lower limits (alarm delay)
 Change rate alarm interval: Measurement period \times 1-15
 Hysteresis: Switched between ON (0.5% of display span) and OFF (same for all channels/levels)
 Display: Status (alarm type) display and common alarm display shown on digital display unit when alarm occurs.
 Switching between display holding/non-holding.
 Notification: Email notification
 Storage: Stored information: Alarm occurrence/clear time, alarm type
 Number of stored records: Most recent 120 records maximum
 Output: Output points: DX100 (with option): 2, 4, or 6 points
 DX200 (with option): 2, 4, 6, 12, or 24 points
 Operations: Switching between excitation/non-excitation, holding/non-holding

Communication functions

Medium: 10BASE-T
 Protocols: SMTP, HTTP, FTP, TCP, UDP, IP, ARP, ICMP
 Email sending function: Notification types:
 The following information is presented by email:
 Alarm notification: Alarm information is presented when an alarm occurs or is cleared.
 System notification: Notification of time when power is interrupted/restored. Notification of time remaining when internal memory overwriting starts. Notification of remaining free space when remaining space in storage media falls to 10%.
 Periodic notification: Periodic notification of instantaneous values at preset times or intervals.
 Report notification: Notification of report data when report time-out occurs (with /M1 option)
 Notification addressee: 2 address groups (multiple addresses may be specified in each group, with a maximum of 150 characters per group)
 Web server function: Displays the DX unit's screen, alarm information, instantaneous values, etc. on a browser. Messages can be input to the DX unit from the browser.
 FTP client function: Automatic file transfer from DX unit (display data files, event files, report file)
 FTP server function: Manual file transfer of information on removable storage media, directory editing, file deletion, and checking free space on removable storage media, working through a host computer
 Real-time monitor function: Real-time remote monitoring of DX unit measurement data (special protocol)

Power supply

Rated supply voltage: 100-240 VAC (automatic switching)
 Operating supply voltage range: 90-132, 180-264 VAC
 Rated supply frequency: 50/60 Hz (automatic switching)

DX100 power consumption

Supply voltage	With LCD saver ON	Normal mode	Maximum
100 VAC	Approximately 30 VA	Approximately 32 VA	Approximately 45 VA
240 VAC	Approximately 42 VA	Approximately 47 VA	Approximately 62 VA

DX200 power consumption

Supply voltage	With LCD saver ON	Normal mode	Maximum
100 VAC	Approximately 50 VA	Approximately 53 VA	Approximately 75 VA
240 VAC	Approximately 78 VA	Approximately 80 VA	Approximately 106 VA

Normal operating requirements

Supply voltage ranges : 90 to 132, 180 to 250 V AC
 Supply frequencies : 50 Hz \pm 2%, 60 Hz \pm 2%
 Ambient temperature : 0 to 50°C
 Ambient humidity : 20 to 80% RH (at 5 to 40°C)

Reference performance specifications

Measurement and display accuracy :
 (reference operating conditions: temperature of 23 \pm 2°C, humidity 55 \pm 10% RH, supply voltage of 90 to 132 or 180 to 250 V AC, supply frequency of 50/60 Hz \pm 1%, minimum 30 minutes warmup time; no vibrations or other which would adversely affect the performance of measuring instruments)

Input type	Input	Measurement accuracy (digital reading)	Maximum digital reading resolution	
DC voltage	20 mV	\pm (0.1% of rdg + 2 digits)	10 μ V	
	60 mV		10 μ V	
	200 mV		100 μ V	
	2 V		1 mV	
	6 V		1 mV	
	20 V		10 mV	
	50 V		\pm (0.1% of rdg + 3 digits)	10 mV
Thermocouple (without reference junction compensation accuracy)	R	\pm (0.15% of rdg + 1°C) R and S are \pm 3.7°C for 0 to 100°C, and \pm 1.5 for 100 to 300°C And B is \pm 2°C for 400 to 600°C; accuracy not guaranteed for less than 400°C	0.1°C	
	S			
	B			
	K			\pm (0.15% of rdg + 0.7°C) \pm (0.15% of rdg + 1°C) for -200 to -100°C
	E			\pm (0.15% of rdg + 0.5°C)
	J			\pm (0.15% of rdg + 0.5°C) \pm (0.15% of rdg + 0.7°C) for -200 to -100°C
	T			
	N			\pm (0.15% of rdg + 0.7°C)
	W			\pm (0.15% of rdg + 1°C)
	L			\pm (0.15% of rdg + 0.5°C) \pm (0.15% of rdg + 0.7°C) for -200 to 100°C
RTD	Pt100	\pm (0.15% of rdg + 0.38C)		
	JPt100			

Reference junction compensation: INT (internal)/EXT (external) switching (common to all channels)
 Reference junction compensation accuracy

Types R, S, B, W: \pm 1°C
 Types K, J, E, T, N, L, U: \pm 0.5°C (for measurement at 0°C or higher)

Maximum input voltage: 2 VDC or lower voltage range and thermocouple: \pm 10 VDC (continuous)
 6 VDC or higher voltage range: \pm 60 VDC (continuous)

Input resistance: 2 VDC or lower voltage range and thermocouple: 10 M Ω or higher
 6 VDC or higher voltage range: Approximately 1 M Ω

Input external resistance: DC voltage, thermocouple input: 2 k Ω or lower
 RTD input: 1 wire, 10 Ω or less (all three wires equal)
 10 nA or less

Input bias current: 10 nA or less
 Maximum common mode noise voltage: 250 VAC rms (50/60 Hz)

Common mode rejection ratio (CMRR): 120 dB (50/60 Hz \pm 0.1%, 500 Ω unbalanced, across minus terminal and ground)

Normal mode rejection ratio (NMRR): 40 dB (50/60 Hz \pm 0.1%)
 Maximum noise voltage across channels: 250 VAC rms (50/60 Hz)

Interference across channels: 120 dB (for 500 Ω input external resistance and 60 V input to other channel)

Specifications for options

Alarm relay contact output (/AR1, /AR2, /A3, /A4*, /A5*)

Function: Relay output through back side when alarm occurs
 Outputs: 2, 4, 6, 12* or 24*
 Relay contact capacitance: 250 VDC/0.1 A (resistance load), 250 VAC (50/60 Hz)/3 A
 Output form: NO-C-NC (switching between excitation/non-excitation, AND/OR, holding/non-holding)
 * /A4 and /A5 are for DX200 only.

Batch functions

Batch number functions: In operation mode, batch names and comments can be input. Automatic incrementing of lot numbers at each batch start. Preset application names, supervisor names, and manager names can be viewed on the batch input screen.
 Data files: The following information is added to the data file header:
 • User name
 • Application name
 • Supervisor name
 • Manager name
 • Batch name (text string with up to 16 characters, plus 4-digit lot number)
 • Comments (up to 32 characters \times 3 lines)

Serial communications (/C2, /C3)

Functions: Control and settings through host computer, data output to host
 Media: EIA RS-232 (/C2) or RS-422-A/485 (4-wire) (/C3) compliant
 Protocol: Special protocol or Modbus
 Synchronization method: Start-stop synchronization
 Communication method (RS-422-A/485): 4-wire half-duplex multi-drop connection (1:N, where N is 1-32)
 Transfer rate: 1200, 2400, 4800, 9600, 19,200, 38,400 bps
 Data length: 7/8 bits
 Stop bit: 1 bit
 Parity: ODD, EVEN, NONE
 Maximum communication distance: 1.2 km (RS-422-A/485)
 Communication mode: Control and settings I/O are in ASCII mode. Measurement data are output in ASCII or binary mode.
 Modbus communication: Operation mode: RTU MASTER or RTU SLAVE
 Capable of data acquisition for 8 packet groups.
 Registers of a continuous data type in the same slave can be registered in a single packet group.
 RTU SLAVE: Outputs measurement/calculation data and alarm statuses.

FOUNDATION Fieldbus communication functions (/CF1)

Interface: FOUNDATION™ Fieldbus H1 (transfer rate: 31.25 kbps)

Physical type: 113 (standard-power signaling, bus powered, non I.S.)
 Communication line conditions: Power voltage: 9-32 VDC, supply current: 16.5 mA (maximum)
 Connection: M4 screws (2 terminals)
 Signal insulation: 500 Vrms withstand voltage between communication terminal and ground (50/60 Hz, for one minute)
 Device type: Link master
 AI blocks: 8 blocks (one channel per block) for sending DX measurement/calculation data to other equipment
 MAI block: 1 block (8 channels) for sending DX measurement/calculation data to other equipment
 MAO block: 1 block (8 channels) for receiving data from other equipment and displaying/recording the data

VGA output (/D5) (DX200 only)

Enables connection to external display device.

FAIL/memory end output (/F1)

Relay output is performed when a system error occurs, when internal memory overwriting starts, or when the removable storage media free space falls to a certain level.

Manual saving: Relay output a specified number of hours before internal memory overwriting starts (1, 2, 5, 10, 20, 50, or 100 hours).
 Auto-saving: Relay output when the external storage medium free capacity falls to 10%.

Relay contact capacitance: 250 VDC/0.1 A (resistance load), 250 VAC (50/60 Hz)/3 A

Clamp input terminal (/H2)

A clamp input terminal is used as an input terminal.

Desktop type (/H5□, /H5)

Includes carrying handle and power cord (model /H5 does not include power cord)

Calculation functions (/M1)

These functions enable the calculations listed below, as well as displaying and recording trends and digital values on calculation channels.

Number of calculation channels:
 DX102, DX104: 8 channels
 DX106, DX112: 12 channels
 DX204, DX208: 8 channels
 DX210, DX220, DX230: 30 channels

Calculation types
 General calculations: Arithmetic calculations (+, -, *, /), square roots, absolute values, common logarithms, exponents, powers, relational calculations (<, >, =, ≠), logical calculations (AND, OR, NOT, XOR)
 Statistical calculations: Time-series data averages, maximum values, minimum values, totalized values
 Moving averages: Moving averages are determined for calculation results.

Constants
 DX100: Up to 12 constants can be set.
 DX200: Up to 30 constants can be set.

Online digital communications input:
 Can be used for calculation formulas other than statistical calculations.
 DX100: 12 channels
 DX200: 30 channels

Remote inputs:
 Up to 8 remote inputs can be used. Remote statuses (0/1) can be used in calculation formulas.

Reporting functions
 Report types: Hourly reports, daily reports, hourly + daily reports, daily + weekly reports, daily + monthly reports
 Calculation types: Average values, maximum values, minimum values, totalized values

Cu10/Cu25 RTD input/3-wire isolated RTD input (/N1)

This option enables Cu10 and Cu25 inputs in addition to the standard inputs.

3-wire isolated RTD input (/N2)

With this option, all RTD input points are isolated (A, B, and b are all isolated).

* Only available with DX106, DX112, DX210, DX220, and DX230.

24 VDC/AC power driven model (/P1)

Rated supply voltage: 24 VDC or 24 VAC (50/60 Hz)
 Operating supply voltage range: 21.6 to 26.4 VDC/AC
 DX100 power consumption:

Supply voltage	With LCD saver ON	Normal mode	Maximum
24 VDC	17 VA	19 VA	30 VA
24 VAC (50/60 Hz)	28 VA	32 VA	45 VA

DX200 power consumption

Supply voltage	With LCD saver ON	Normal mode	Maximum
24 VDC	34 VA	35 VA	54 VA
24 VAC (50/60 Hz)	50 VA	53 VA	76 VA

Remote control (/R1)

The remote control can be used to control the following through contact input (as many as 8 points can be set):

- Memory start/stop (level)
- Event file external trigger input (level)
- Time setting (time set to reference time through contact; trigger; 250 ms or greater)
- Calculation start/stop (level)
- Calculation data reset (trigger; 250 ms or greater)
- Manual sampling (trigger; 250 ms or greater)
- Message writing (as many as 8 types can be set; trigger; 250 ms or greater)
- Load settings (as many as 3 types can be set; trigger; 250 ms or greater)
- Alarm ACK (trigger; 250 ms or greater)
- Snapshot (trigger; 250 ms or greater)

24 VDC transmitter power supply output (/TPS2*, /TPS4, /TPS8*)

Output voltage: 22.8-25.2 VDC (for rated load current)
 Rated output current: 4-20 mA DC
 Maximum output current: 25 mA DC (overcurrent assured operation current: approximately 68 mA DC)
 Permitted conductor resistance: $RL \leq (17.8 - \text{transmitter minimum operating voltage})/0.02 \text{ A}$ (250 Ω load shunt resistance; drop voltage not included)
 Maximum cable length: 2 km (using CEV cable)
 Insulating resistance: 20 MΩ or greater across output and main unit ground (500 VDC)
 Withstand voltage: 500 VAC across output and main unit ground (50/60 Hz; I = 10 mA), for one minute
 Across output terminals: 500 VAC (50/60 Hz; I = 10 mA), for one minute
 * /TPS2 is for DX100; /TPS8 is for DX200 only.

Application software (DAQSTANDARD)

System requirements

Operating system: Microsoft Windows 98/Me/2000/NT4.0/XP
 Processor: Pentium 166 MHz MMX or higher (Pentium II 266 MHz or higher recommended)
 RAM: 32MB or more (64MB or more recommended)
 Disk drive: CD-ROM compatible with Windows 98/Me/2000/NT4.0/XP
 Free hard drive space: 10MB or more (100MB or more recommended)
 Video card: Video card compatible with Windows 98/Me/2000/NT4.0/XP and capable of displaying 32,000 colors or more (video card capable of displaying 64,000 colors or more recommended)
 Printer and printer driver compatible with Windows 98/Me/2000/NT4.0/XP

Main functions (package)

Setup software: Removable storage media: Setup and set mode settings
 Online settings: Setup and set mode settings other than communication-related settings (e.g., IP address)
 Data Viewer: Number of display channels: 32 channels per group, maximum 30 groups
 Display functions: Waveform display, digital display, circular display, list display, TLOG display, report display, etc.
 Linked file display: Data files generated by breaking up contiguous data into multiple files during continuous data acquisition (due to auto-saving or a power interruption) can be displayed as linked files. (A total of one million data entries may be linked together.)
 Interval calculations: Maximum, minimum, average, rms, p-p
 File conversion: Conversion to ASCII, Lotus 1-2-3, and Excel formats
 Printouts: Printouts of replayed data

Dimensions

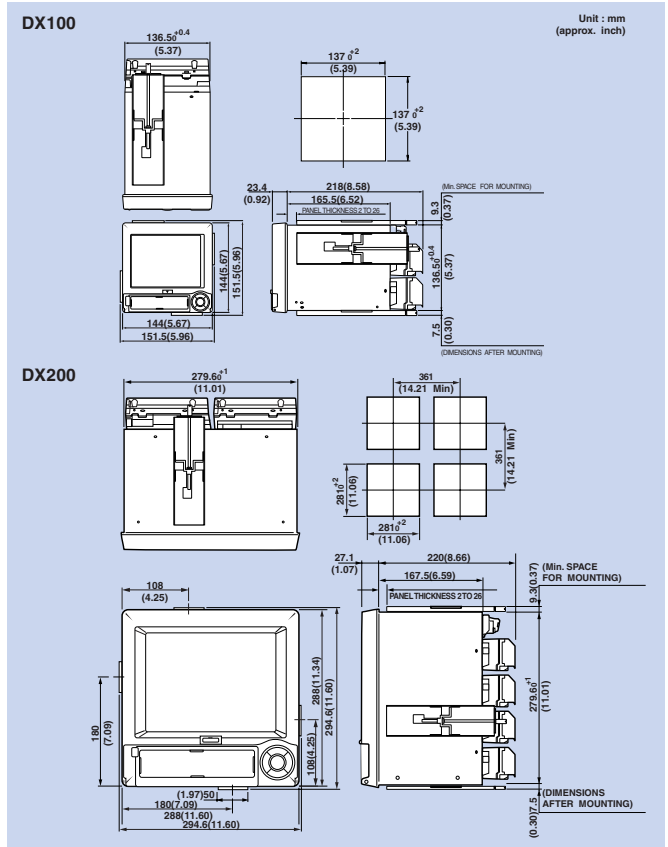

Two panel brackets are used in panel-mounting the DX100 and DX200. They may be used either on the left and right or top and bottom. See Yokogawa's General Specification (GS 4L1A1-E) for information on panel cutting dimensions for DX100 vertical or horizontal attachments. Unless otherwise indicated, tolerance is ±3% (or ±0.3 mm for dimensions under 10 mm).

DAQSTATION is a registered trademark of Yokogawa Electric Corporation.
 "Field Content on the Web" is an English equivalent of the Japanese trademark registered in Japan by Yokogawa Electric Corporation.
 Microsoft, MS, and Windows are registered trademarks or trademarks of Microsoft Corporation in the United States and other countries.
 Lotus and 1-2-3 are registered trademarks of Lotus Development Corporation.
 MMX and Pentium are registered trademarks of Intel Corporation.
 Ethernet is a registered trademark of Xerox Corporation.
 Modbus is a registered trademark of AEG Schneider Automation Inc.
 FOUNDATION Fieldbus and the logo of Fieldbus Foundation are registered trademarks of the Fieldbus Foundation.
 Zip and the logos are registered trademarks or trademarks of Iomega Corporation.
 Other company names and product names appearing in this document are registered trademarks or trademarks of their respective holders.

Options

DX100

Model code	Suffix code	Optional code	Description
DX102			DAQSTATION DX100 (2 ch)
DX104			DAQSTATION DX100 (4 ch)
DX106			DAQSTATION DX100 (6 ch)
DX112			DAQSTATION DX100 (12 ch)
External memory	-1		FDD
	-3		CompactFlash memory card (CF+Adapter)
	-5		250 MB Zip (with medium)
Display language	-2		English/Germany/French, deg F & Summer/winter time (with English DAQSTANDARD)
Options	/AR1		Alarm output 2 points/Remote control*1*2
	/AR2		Alarm output 4 points/Remote control*1*2
	/A3		Alarm output 6 points*1*3
	/BT1		Batch function
	/C2		RS-232 interface (including Modbus Master/Slave protocol)*4*5
	/C3		RS-422-A/485 interface (including Modbus Master/Slave protocol)*4*5
	/CF1		FOUNDATION Fieldbus*4*6
	/F1		Fail/memory end detection and output*3
	/H2		Clamped input terminal
	/H5		Desktop type (without power code, screw type power terminal)*7
	/H5[]		Desktop type (with power code)*8
	/M1		Mathematical function (with report function)
	/N1		Cu10, Cu25 RTD input/3 legs isolated RTD
	/N2		3 legs isolated RTD*9
	/P1		24 VDC/AC power supply
/TPS2		24 VDC transmitter power supply (2 loops)*10	
/TPS4		24 VDC transmitter power supply (4 loops)*11	
/R1		Remote control	

- *1 /AR1, /AR2, and /A3 cannot be specified together.
 *2 If /AR1 or /AR2 is specified, /R1 cannot be specified.
 *3 If /A3 is specified, /F1 cannot be specified.
 *4 /C2, /C3, and /CF1 cannot be specified together.
 *5 In case that Modbus master function is utilized, /M1 must be specified.
 *6 In case that FOUNDATION Fieldbus (/CF1) is specified, /M1 must be specified together.
 *7 In case that 24 VDC/AC power supply (/P1) and desktop type are specified together, /H5 must be specified.
 *8 /P1 and /H5[] cannot be specified together.
 *9 /N2 cannot be specified for DX102, DX104.
 *10 In case that /TPS2 is specified, /TPS4, /AR2, /A3, or /F1 cannot be specified.
 *11 In case that /TPS4 is specified, /TPS2, /AR1, /AR2, /A3, or /F1 cannot be specified.

DX200

Model code	Suffix code	Optional code	Description
DX204			DAQSTATION DX200 (4 ch)
DX208			DAQSTATION DX200 (8 ch)
DX210			DAQSTATION DX200 (10 ch)
DX220			DAQSTATION DX200 (20 ch)
DX230			DAQSTATION DX200 (30 ch)
External memory	-1		FDD
	-3		CompactFlash memory card (CF+Adapter)
	-5		250 MB Zip (with medium)
Display language	-2		English/Germany/French, deg F & Summer/winter time (with English DAQSTANDARD)
Options	/AR1		Alarm output 2 points/Remote control*1*2
	/AR2		Alarm output 4 points/Remote control*1*2
	/A3		Alarm output 6 points*1
	/A4		Alarm output 12 points*1
	/A5		Alarm output 24 points*1*3
	/BT1		Batch function
	/C2		RS-232 interface (including Modbus Master/Slave protocol)*4*5
	/C3		RS-422-A/485 interface (including Modbus Master/Slave protocol)*4*5
	/CF1		FOUNDATION Fieldbus*4*6
	/D5		VGA video output
	/F1		Fail/memory end detection and output*3
	/H2		Clamped input terminal
	/H5		Desktop type (without power code, screw type power terminal)*7
	/H5[]		Desktop type (with power code)*8
	/M1		Mathematical function (with report function)
/N1		Cu10, Cu25 RTD input/3 legs isolated RTD	
/N2		3 legs isolated RTD*9	
/P1		24 VDC/AC power supply	
/TPS4		24 VDC transmitter power supply (4 loops)*10	
/TPS8		24 VDC transmitter power supply (8 loops)*11	
/R1		Remote control	

- *1 /AR1, /AR2, /A3, /A4, /A5 cannot be specified together.
 *2 If /AR1 or /AR2 is specified, /R1 cannot be specified.
 *3 If /A5 is specified, /F1 cannot be specified.
 *4 /C2, /C3, and /CF1 cannot be specified together.
 *5 In case that Modbus master function is utilized, /M1 must be specified.
 *6 In case that FOUNDATION Fieldbus (/CF1) is specified, /M1 must be specified together.
 *7 In case that 24 VDC/AC power supply (/P1) and desktop type are specified together, /H5 must be specified.
 *8 /P1 and /H5[] cannot be specified together.
 *9 /N2 cannot be specified for DX204, DX208.
 *10 In case that /TPS4 is specified, /TPS8 or /A5 cannot be specified.
 *11 In case that /TPS8 is specified, /TPS4 or /A5 cannot be specified.
 In case that /TPS8 is specified, /F1 and /A4 cannot be specified together.

Application Software

Model	Description	Operating System
DXA100-02	DAQSTANDARD	Windows 98/Me/NT4.0/2000/XP
WX104/CD1	DAQEXPLORER	Windows 2000/XP
DXA310-021	DAQ-PharmBio	Windows 98/Me/NT4.0/2000/XP
DXA410-02	DAQOPC(Basic)	Windows 2000/XP
DXA410-04	DAQOPC(Advanced)	Windows 2000/XP
WX101/CD1	DAQLOGGER(1600 channels)	Windows 2000/XP
WX81/CD1	DAQLOGGER Client(1600 channels)	Windows 2000/XP

Accessories

Accessories (sold separately)

Product	Product Model (part number)	Specification
Shunt resistor for screw terminal (standard)	415920	250 Ω ± 0.1%
	415921	100 Ω ± 0.1%
	415922	10 Ω ± 0.1%
Shunt resistor for clamp terminal (for/H2)	438920	250 Ω ± 0.1%
	438921	100 Ω ± 0.1%
	438922	10 Ω ± 0.1%
3.5-inch floppy disks	705900	2HD (10 disks)
Zip disk	A1056MP	250 MB
CompactFlash memory card (CF+Adapter)	B9968NL	32 MB or more
	A1347EF(DX100)	250V 1A TL
Fuse	A1423EF(DX200)	250V 1.25A TL
	A1352EF(DX100)	250V 4A TL (for /P1)
	A1463EF(DX200)	250V 6.3A TL (for /P1)
Bracket	B9900BX	-
Module removal handle	790581	-

Related Products

DX100L DAQSTATION Special Housing Model



Special housing model for advanced network functions

- ◆ Works with recorders with different panel cuts and depths than the standard DX100.
- ◆ Foxboro(SPEC200),

NOTICE

- Before operating the product, read the instruction manual thoroughly for proper and safe operation.
- If this product is for use with a system requiring safeguards that directly involve personnel safety, please contact the Yokogawa sales offices.

YOKOGAWA

YOKOGAWA ELECTRIC CORPORATION

Network Solutions Business Div./Phone: (81)-422-52-7179, Fax: (81)-422-52-6619

E-mail: ns@cs.jp.yokogawa.com

YOKOGAWA CORPORATION OF AMERICA

YOKOGAWA EUROPE B.V.

YOKOGAWA ENGINEERING ASIA PTE. LTD.

Phone: 800-888-6400, Fax: (1)-770-251-6427

Phone: (31)-33-4641806, Fax: (31)-33-4641807

Phone: (65)-62419933, Fax: (65)-62412606

NetSOL Online Sign up for our free e-mail newsletter
www.yokogawa.com/ns/

Subject to change without notice.

[Ed : 05/b] Copyright ©2000

Printed in Japan, 604(KP)